



Beautiful sparkle, reliable life

MASTERColour CDM-TD

Range of double-ended, compact, high-efficiency, discharge lamps with a stable color over lifetime and a crisp, sparkling light

Benefits

- Stable color impression over lifetime
- High lamp efficacy results in low operating costs and low heat generation. Provides better operating costs and improved light quality versus standard quartz metal halide (MHN-TD)
- Long lamp life compared with incandescent, halogen and quartz metal halide (MHN-TD) lamps
- Relatively low heat output enhances comfort for shoppers and staff
- All types are UV-Block for reduced fading risks

Features

- Crisp white light
- Superior color quality
- Retrofit in double-ended luminaires for quartz metal halide lamps (MHN-TD), thereby allowing to reduce operating costs and improve color quality
- Burning position horizontal $\pm 45^\circ$

Application

- Shops and shop windows, offices and public buildings
- Decorative outdoor: floodlighting of facades, statues and monuments

Warnings and Safety

- Use only in totally enclosed luminaire, even during testing (IEC61167, IEC 62035, IEC60598)
- The luminaire must be able to contain hot lamp parts if the lamp ruptures
- Lamps may use electronic or electromagnetic control gear
- Control gear must include end-of-life protection (IEC61167, IEC 62035)

Related products

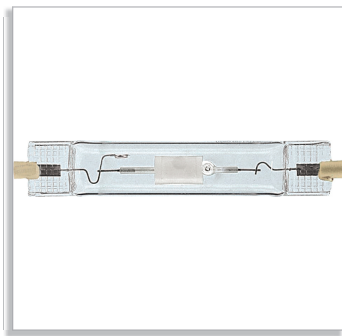

CDM-TD, 150W



CDM-TD, 70W

Dimensional drawing

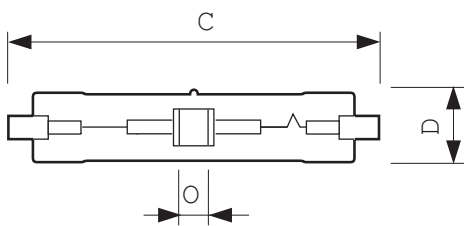

CDM-TD

Product	C (Max)	D (Max)	O (Min)	O (Norm)	O (Max)
CDM-TD 70W/830 RX7s	119.63	22	-	8	-
CDM-TD 70W/830 RX7s	119.63	22	-	8	-
CDM-TD 150W/830 RX7s	137.43	25	-	10	-
CDM-TD 150W/830 RX7s	137.43	25	-	10	-
CDM-TD 70W/942 RX7s	119.63	22	-	7	-
CDM-TD 70W/942 RX7s	119.63	22	-	7	-
CDM-TD 150W/942 RX7s	137.43	25	-	10	-
CDM-TD 150W/942 RX7s	137.43	25	-	10	-

General Characteristics

Order code	Full product name	Bulb	Bulb Finish	Cap-Base	Operating Position	Life to 10% failures	Life to 20% failures	Life to 5% failures	Life to 50% failures
928083605133	MASTERColour CDM-TD 150W/830 RX7s 1CT	T25	Clear	RX7s	p45	13000 hr	15000 hr	9000 hr	16000 hr
928083605177	MASTERColour CDM-TD 150W/830 RX7s 1CT	T25	Clear	RX7s	p45	13000 hr	15000 hr	9000 hr	16000 hr
928084805133	MASTERColour CDM-TD 150W/942 RX7s 1CT	T25	Clear	RX7s	p45	13000 hr	15000 hr	9000 hr	16000 hr
928084805177	MASTERColour CDM-TD 150W/942 RX7s 1CT	T25	Clear	RX7s	p45	13000 hr	15000 hr	9000 hr	16000 hr
928082205125	MASTERColour CDM-TD 70W/830 RX7s 1CT	T22	Clear	RX7s	p45	13000 hr	15000 hr	9000 hr	16000 hr
928082205178	MASTERColour CDM-TD 70W/830 RX7s OEM 1CT	T22	Clear	RX7s	p45	13000 hr	15000 hr	9000 hr	16000 hr
928084705133	MASTERColour CDM-TD 70W/942 RX7s 1CT	T22	Clear	RX7s	p45	13000 hr	15000 hr	9000 hr	16000 hr
928084705177	MASTERColour CDM-TD 70W/942 RX7s OEM 1CT	T22	Clear	RX7s	p45	13000 hr	15000 hr	9000 hr	16000 hr

Installation diagrams

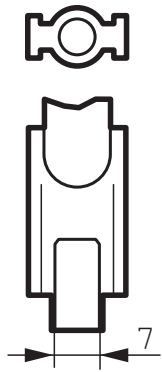

RX7s

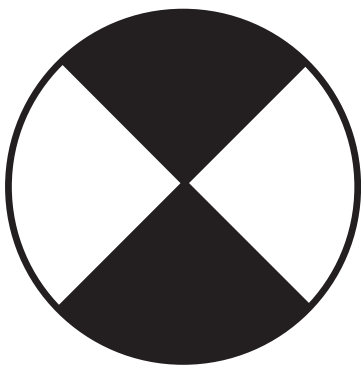

p45

Light Technical Characteristics (1/2)

Order code	Full product name	Color Code	Color Designation (text)	Luminous Flux Lamp EM	Chromaticity Coordinate X	Chromaticity Coordinate Y	Color Rendering Index	Lumen Maintenance 10000h	Lumen Maintenance 2000h	Lumen Maintenance 5000h	Luminous Efficacy Lamp EM
928083605133	MASTERColour CDM-TD 150W/830 RX7s 1CT	830	Warm White	13250 Lm	0.431 -	0.390 -	88 Ra8	75 %	90 %	85 %	85 Lm/W
928083605177	MASTERColour CDM-TD 150W/830 RX7s 1CT	830	Warm White	13250 Lm	0.431 -	0.390 -	88 Ra8	75 %	90 %	85 %	85 Lm/W
928084805133	MASTERColour CDM-TD 150W/942 RX7s 1CT	942	Cool White	14200 Lm	0.370 -	0.368 -	96 Ra8	70 %	90 %	85 %	91 Lm/W
928084805177	MASTERColour CDM-TD 150W/942 RX7s 1CT	942	Cool White	14200 Lm	0.370 -	0.368 -	96 Ra8	70 %	90 %	85 %	91 Lm/W

Order code	Full product name	Color Code	Color Designation (text)	Luminous Flux Lamp EM	Chromaticity Coordinate X	Chromaticity Coordinate Y	Color Rendering Index	Lumen Maintenance 10000h	Lumen Maintenance 2000h	Lumen Maintenance 5000h	Luminous Efficacy Lamp EM
928082205125	MASTERColour CDM-TD 70W/830 RX7s 1CT	830	Warm White	6500 Lm	0.434 -	0.397 -	82 Ra8	70 %	87 %	80 %	86 Lm/W
928082205178	MASTERColour CDM-TD 70W/830 RX7s OEM 1CT	830	Warm White	6500 Lm	0.434 -	0.397 -	82 Ra8	70 %	87 %	80 %	86 Lm/W
928084705133	MASTERColour CDM-TD 70W/942 RX7s 1CT	942	Cool White	6000 Lm	0.375 -	0.364 -	92 Ra8	60 %	85 %	70 %	80 Lm/W
928084705177	MASTERColour CDM-TD 70W/942 RX7s OEM 1CT	942	Cool White	6000 Lm	0.375 -	0.364 -	92 Ra8	60 %	85 %	70 %	80 Lm/W

Light Technical Characteristics (2/2)

Order code	Full product name	Color Temperature	Design Mean Lumens
928083605133	MASTERColour CDM-TD 150W/830 RX7s 1CT	3000 K	Lm
928083605177	MASTERColour CDM-TD 150W/830 RX7s 1CT	3000 K	Lm
928084805133	MASTERColour CDM-TD 150W/942 RX7s 1CT	4200 K	Lm
928084805177	MASTERColour CDM-TD 150W/942 RX7s 1CT	4200 K	Lm
928082205125	MASTERColour CDM-TD 70W/830 RX7s 1CT	3000 K	Lm
928082205178	MASTERColour CDM-TD 70W/830 RX7s OEM 1CT	3000 K	Lm

Order code	Full product name	Color Temperature	Design Mean Lumens
928084705133	MASTERColour CDM-TD 70W/942 RX7s 1CT	4200 K	Lm
928084705177	MASTERColour CDM-TD 70W/942 RX7s OEM 1CT	4200 K	Lm

Light technical

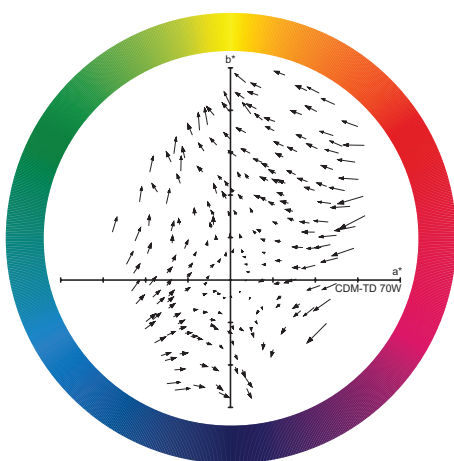

CDM-TD 70W

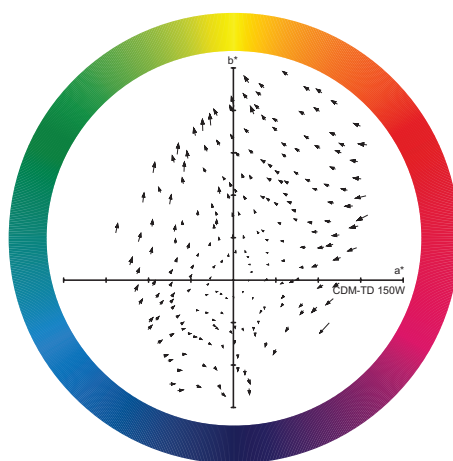

CDM-TD 150W

Light technical

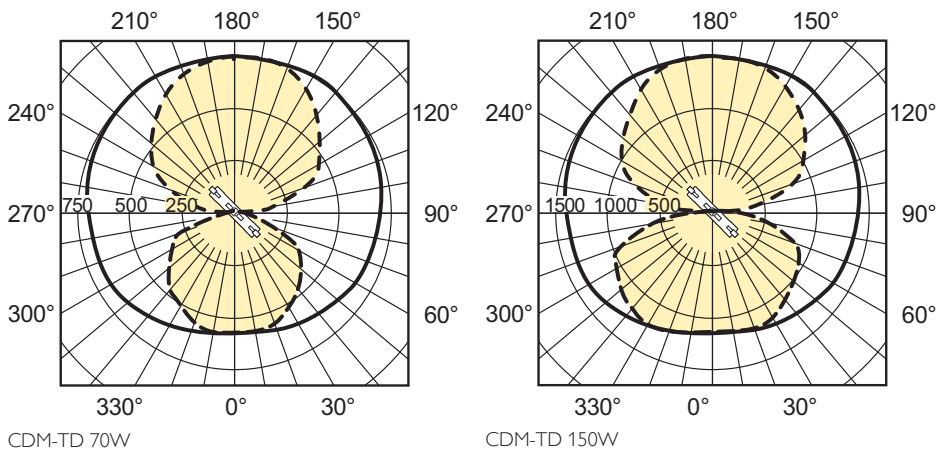

Electrical Characteristics

Order code	Full product name	Lamp Wattage	Lamp Wattage EM	Lamp Voltage	Lamp Current EM	Dimmable	Order code	Full product name	Lamp Wattage	Lamp Wattage EM	Lamp Voltage	Lamp Current EM	Dimmable
928083605133	MASTERColour CDM-TD 150W/830 RX7s 1CT	150 W	145.0 W	96 V	1.8 A	No	928084705133	MASTERColour CDM-TD 70W/942 RX7s 1CT	70 W	71.0 W	89 V	0.99 A	No
928083605177	MASTERColour CDM-TD 150W/830 RX7s 1CT	150 W	145.0 W	96 V	1.8 A	No	928084705177	MASTERColour CDM-TD 70W/942 RX7s OEM 1CT	70 W	71.0 W	89 V	0.99 A	No
928084805133	MASTERColour CDM-TD 150W/942 RX7s 1CT	150 W	149.0 W	100 V	1.82 A	No							
928084805177	MASTERColour CDM-TD 150W/942 RX7s 1CT	150 W	149.0 W	100 V	1.82 A	No							
928082205125	MASTERColour CDM-TD 70W/830 RX7s 1CT	70 W	71.0 W	92 V	0.97 A	No							
928082205178	MASTERColour CDM-TD 70W/830 RX7s OEM 1CT	70 W	71.0 W	92 V	0.97 A	No							

Performance diagrams

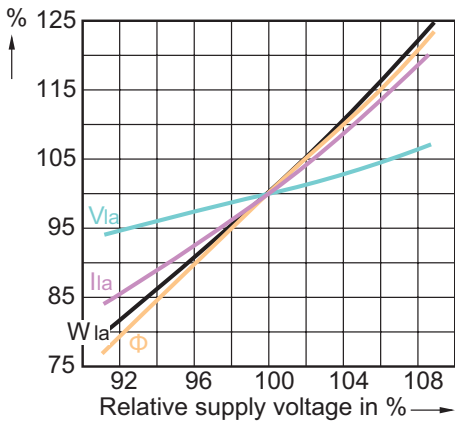

CDM-TD /830

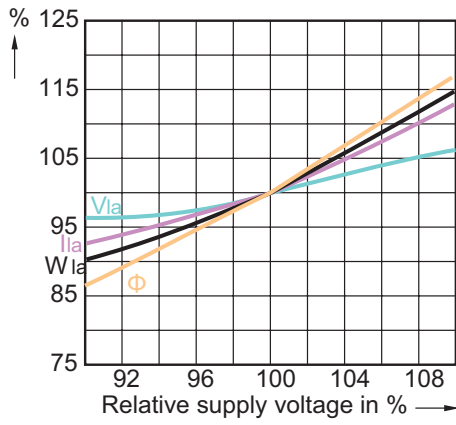

CDM-TD /942

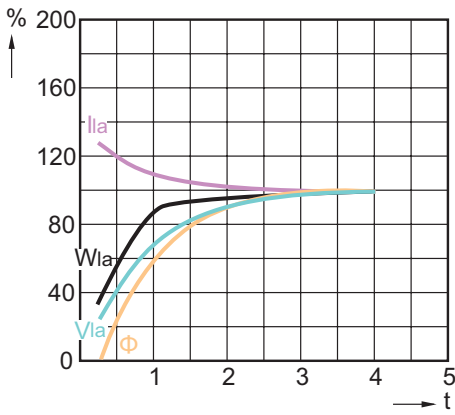

CDM-TD

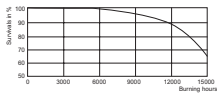

CDM-TD

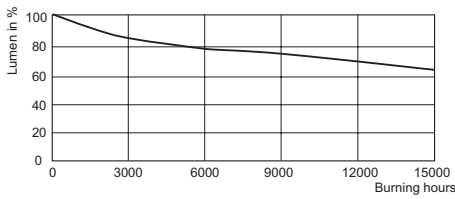

CDM-TD

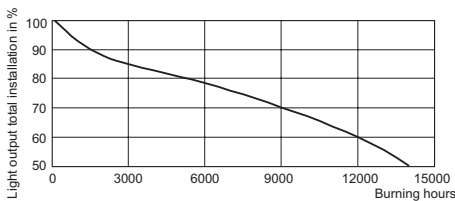

CDM-TD

Environmental Characteristics

Order code	Full product name	Mercury (Hg) Content
928083605133	MASTERColour CDM-TD 150W/830 RX7s 1CT	10.23 mg
928083605177	MASTERColour CDM-TD 150W/830 RX7s 1CT	10.23 mg
928084805133	MASTERColour CDM-TD 150W/942 RX7s 1CT	8.4 mg
928084805177	MASTERColour CDM-TD 150W/942 RX7s 1CT	8.4 mg
928082205125	MASTERColour CDM-TD 70W/830 RX7s 1CT	3.7 mg
928082205178	MASTERColour CDM-TD 70W/830 RX7s OEM 1CT	3.7 mg
928084705133	MASTERColour CDM-TD 70W/942 RX7s 1CT	4.8 mg
928084705177	MASTERColour CDM-TD 70W/942 RX7s OEM 1CT	4.8 mg

Luminaire Design Requirements

Order code	Full product name	Bulb Temperature
928083605133	MASTERColour CDM-TD 150W/830 RX7s 1CT	650 (max) C
928083605177	MASTERColour CDM-TD 150W/830 RX7s 1CT	650 (max) C
928084805133	MASTERColour CDM-TD 150W/942 RX7s 1CT	650 (max) C
928084805177	MASTERColour CDM-TD 150W/942 RX7s 1CT	650 (max) C
928082205125	MASTERColour CDM-TD 70W/830 RX7s 1CT	500 (max) C
928082205178	MASTERColour CDM-TD 70W/830 RX7s OEM 1CT	500 (max) C
928084705133	MASTERColour CDM-TD 70W/942 RX7s 1CT	500 (max) C
928084705177	MASTERColour CDM-TD 70W/942 RX7s OEM 1CT	500 (max) C



© 2012 Koninklijke Philips Electronics N.V.
All rights reserved.

Specifications are subject to change without notice. Trademarks are the property of Koninklijke Philips Electronics N.V. or their respective owners.

www.philips.com/lighting

2012, March 17
data subject to change